

swing system drawing of sliding doors suspension system

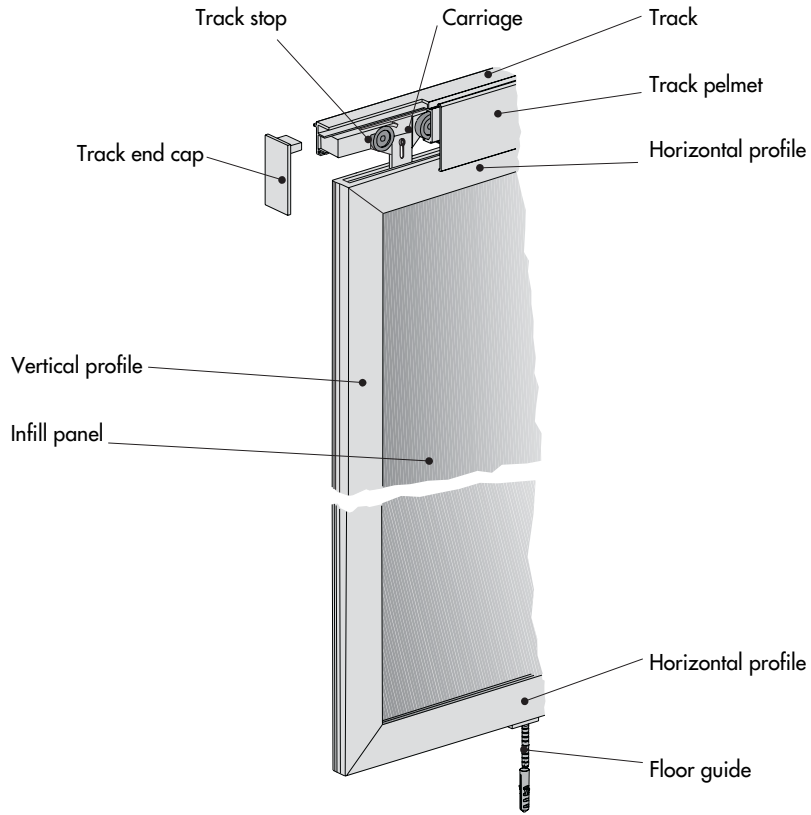

swing system drawing of sliding doors floor system

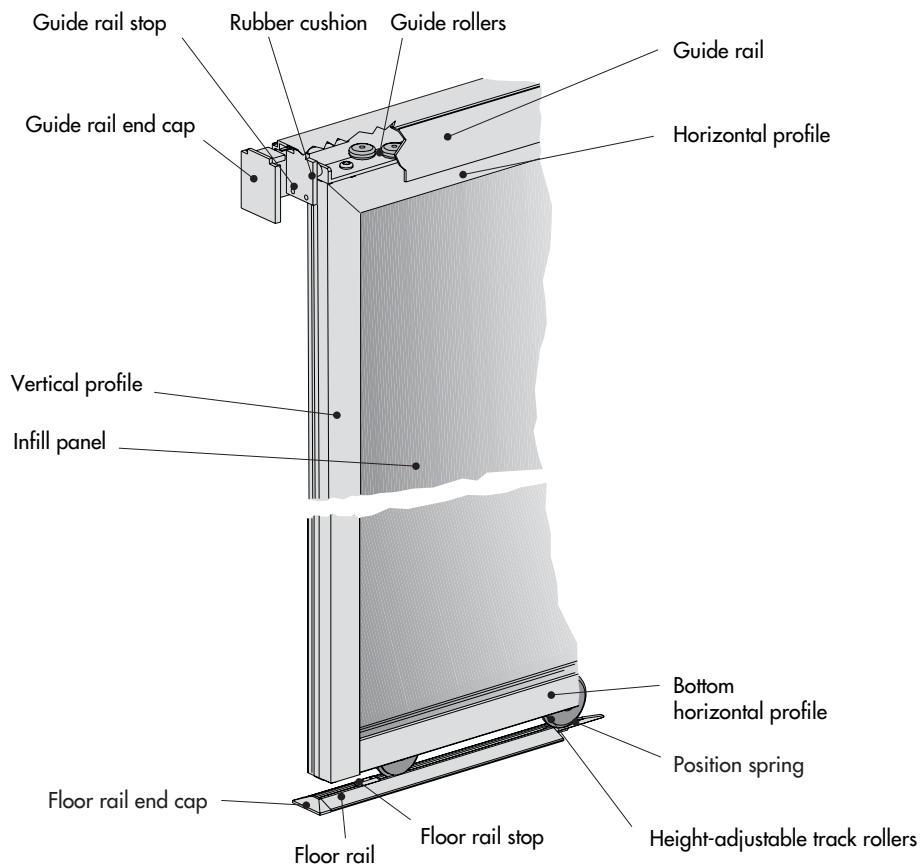

swing model versions and installation options for suspension system "H" and floor system "B"

single-leaf

sliding in front of the wall
(wall installation)

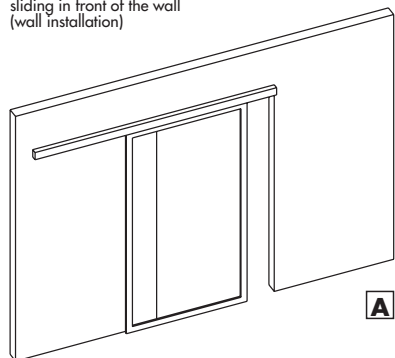

A

sliding in the wall

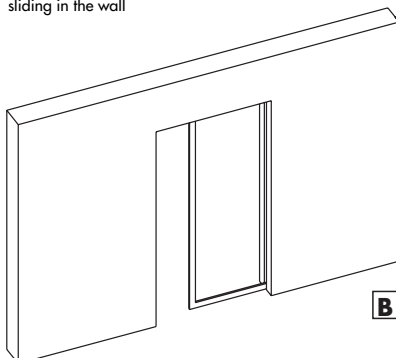

B

sliding under the ceiling
(ceiling installation)

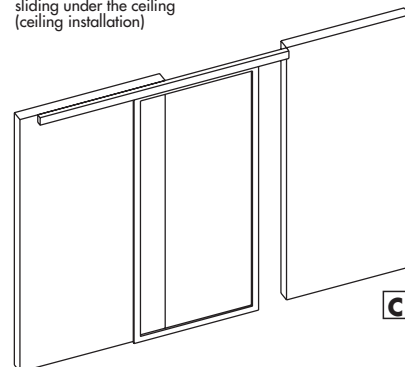

C

double-leaf

sliding in front of the wall
(wall installation)

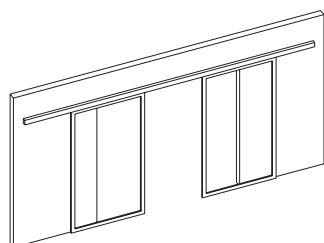

D

sliding in the wall

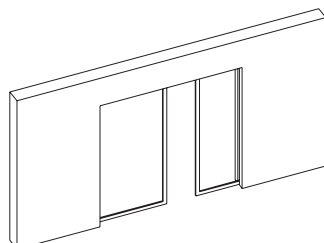

E

sliding under the ceiling
(ceiling installation)

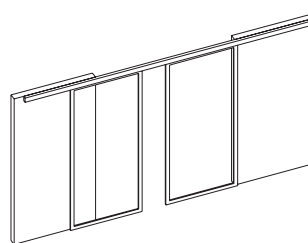

F

sliding between walls
2 tracks
(ceiling installation)

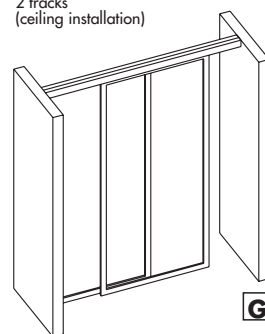

G

three-leaf

sliding under the ceiling
2 tracks
(ceiling installation)

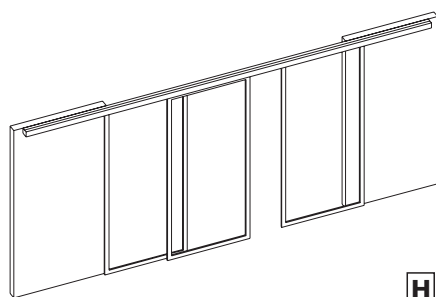

H

sliding between walls
2 tracks
(ceiling installation)

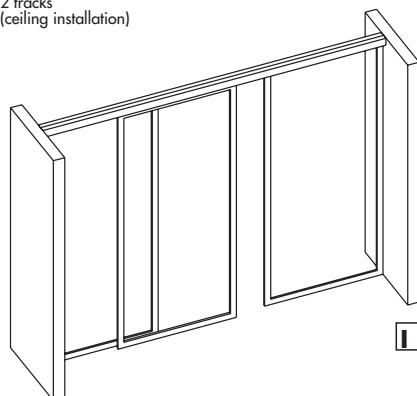

I

sliding between walls
3 tracks
(ceiling installation)

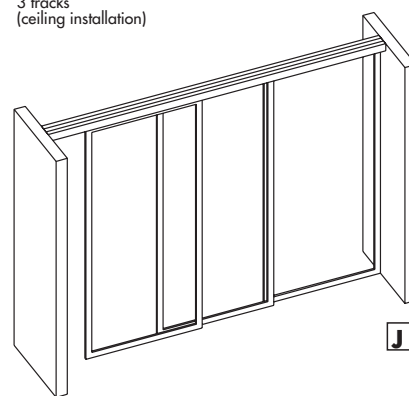

J

four-leaf

sliding under the ceiling
2 tracks
(ceiling installation)

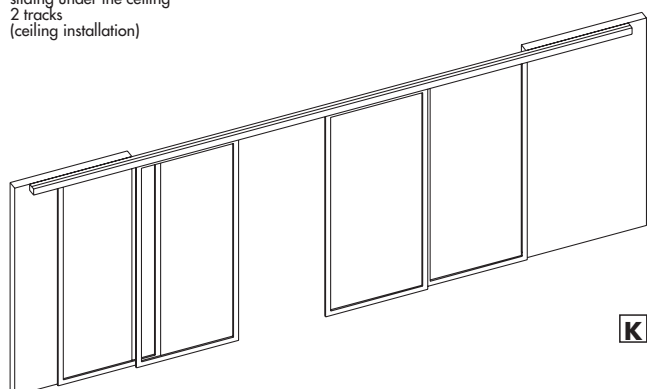

K

sliding between walls
2 tracks
(ceiling installation)

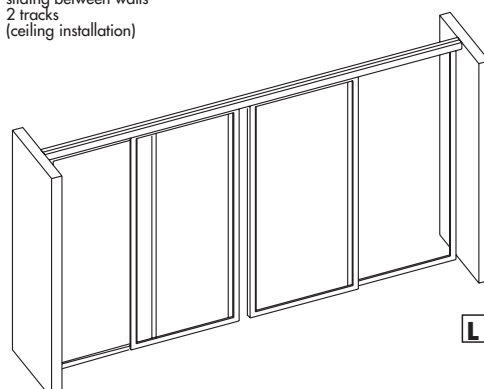

L

swing measurements sheet 1/2

Suspension system "H"

Floor system "B"

opening direction

opening to the right

Measurements for installation (A - L)

opening to the left

e. g. suspension system, double leaf, sliding in front of the wall = HD

Height measurements of clear opening

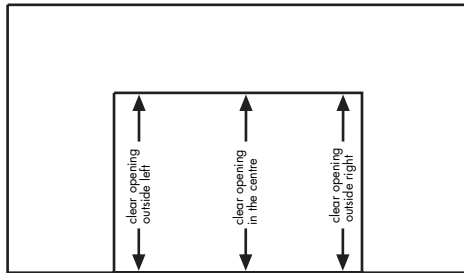

First measure the heights of the clear opening where the doors are to be installed:

Clear opening on left = mm

Clear opening in the centre = mm

Clear opening on right = mm

Width measurements of clear opening

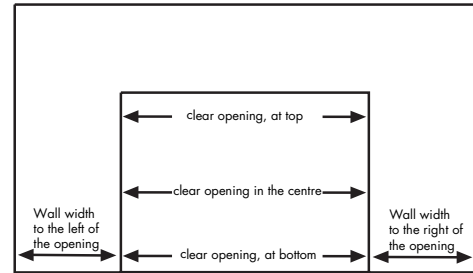

Now measure the widths of the clear opening where the doors are to be installed:

Clear opening at top = mm

Clear open in the centre = mm

Clear opening at bottom = mm

Wall width on left = mm

Wall width on right = mm

Room heights

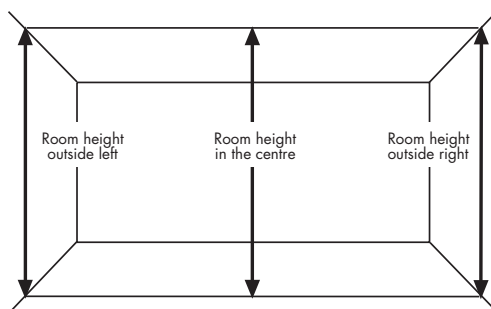

Then measure the room heights at the point where the doors are to be installed:

Room height on left = mm

Room height in the centre = mm

Room height on right = mm

Room widths

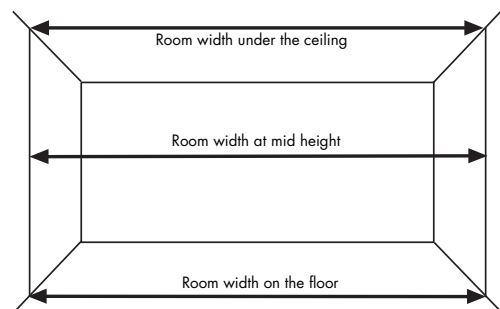

Last of all measure the width of the room, at the point where the doors are to be installed:

Width under the ceiling = mm

Width at mid height = mm

Width on the floor = mm

NOTE: the height measurements must be specified from the finished floor line (FFL) !

swing measurements sheet 2/2
Finish of doors from left to right

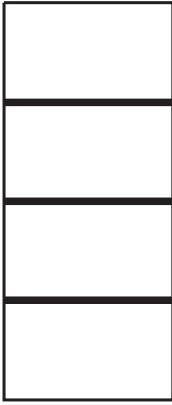
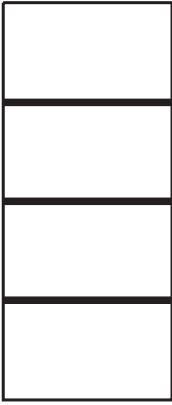
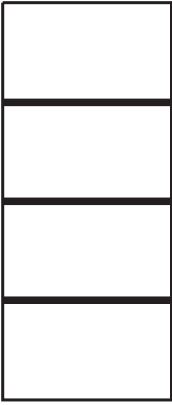
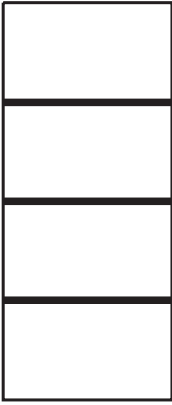
Finish	leaf 1		leaf 2		leaf 3		leaf 4	
	Visible side		Visible side		Visible side		Visible side	
	Front face	Reverse face	Front face	Reverse face	Front face	Reverse face	Front face	Reverse face
Decor, white K01								
Decor, aluminium colour K02								
Decor, maple K14								
Safety glass, white matt G50								
Safety glass, clear G54								
Safety glass, Mastercarré G65								
Lacobel glass, soft white G31								
Lacobel glass, metallic grey G37								
Lacobel glass, red G38								
Mirror G59								
Lacquer, white RAL 9016 L01								
Lacquer, cream RAL 9001 L06								
Lacquer, silk grey RAL 7044 L05								
Lacquer, special colours L00								
Wood veneer, natural oak H10								
Wood veneer, limed oak, cross v. H12								
Wood veneer, bog oak H13								
Wood veneer, maple H14								
Wood veneer, wenge, cross v. H18								
Optional extras	Sliding door 1		Sliding door 2		Sliding door 3		Sliding door 4	
Number of decorative strips per side								
Front face								
Reverse face								
Number of infill dividing horizontal profiles								
using different infills								
Horizontal profile, 32 mm high								
Note: specify top edge of horizontal profiles, otherwise equal spacing will be assumed (if less fields are required, please delete)								
Appearance of infill using infill-dividing horizontal profiles Please enter the code for the required surface finish into the corresponding fields. (e. g. print decor white "K01")								
Wall distance profile, aluminium 16 mm - <u>only for swing suspension system</u> -								
	one side	both sides	one side	both sides	one side	both sides	one side	both sides
Handle option, aluminium rod 10 mm								
Handle option, aluminium rod 16 mm								
Extra charge for powder-coating to RAL for: aluminium frame profile/track pelmet/ aluminium rod per leaf/outer guide profile (floor rail aluminium-coloured only)	on request		on request		on request		on request	
Extra price for aluminium vertical lead-in profile 20x35x20xmm silver-coloured anodized (for installation type B/G/I/J/L)								